

PMRV / PRV
PLUS+ PLUS+

Worm Geared

GEAR UNIT WITH MOTORS / WITHOUT MOTORS





MAINTENANCE AND OPERATION INSTRUCTIONS










The copyrights of the usage Maintenance instruction are belong to NRW company.
Usage guide could not be used partially or fully without our permission to the purpose of competition and not submitted to the use of third parties.

The right of changing informations which stated in the usage maintenance instruction partially or fully without giving any notice before or right of full changing and abolishment are kept reserved by us.



	GENERAL INFORMATION	1. UNIT
	1.1 Important Warnings	5
	1.2 General Information	6
	1.3 Correct Use	6
	1.4 Safety Information	6
	1.5 Responsibility	7
	1.6 Transportation	7 - 9
	1.6.1 Transportation and Freightage	7
	1.6.2 Package Transportation	7
	1.6.3 Equipment Transportation	8
	1.6.4 Transport of Gearboxes	9
	1.7 Storage	10
	1.7.1 Long Term Storage Suggestions	10
	PRODUCT DESCRIPTION	2. UNIT
	2.1 Gear Unit Label	11
	2.2 Explanations	12
	2.3 Abbreviations	13
	ASSEMBLY INSTRUCTIONS; PREPARATION, INSTALLATION	3. UNIT
	3.1 Prerequisites of Assembly	14
	3.2 Critical Applications	15
	3.3 Gear Unit Mounting	16
	3.4 Bolt Tightening Torque Value	17
	3.5 Gear Unit Ventilation	17
	3.6 Retrospective Paintwork	18
	3.7 The Mountage of the Connection Tool to the Output Shaft	18
	3.8 The Mountage of the Couplings	18
	3.9 The Mountage of the Standard B5 Motor to the PAM Gear Unit	19
	3.10 The Demountage of the Electrical Motor (PAM)	19
	3.11 Gear Unit Operating	19
	CONTROL AND MAINTENANCE	4. UNIT
	4.1 Control and Periodic Maintenance	20
	4.2 Visual Inspection	21
	4.3 Check for Running Noises	21
	4.4 Control of the Lubricant and Lubricant Level	21
	4.5 Changing the Oil	21
	4.6 Oil Plugs Squeezing Torc Chart	22
	4.7 Change of the Ventilation Plug	22
	4.8 Change of the Oil Seal and Oil Cover	22
	4.9 The Bearing Greases	22
	4.10 General Overhaul	22
	4.11 The Maintenance of the Motor	22



	MOUNTING POSITIONS	5. UNIT
	5.1 Mounting Positions	23 - 29
	5.2 Terminal Box and Cable Entrance Sides	30 - 31
	LUBRICATION	6. UNIT
	6.1 Lubrication	32
	6.2 Lubricant Fill Quantities	32
	6.3 Lubrication Table	33
	ACCESSORIES	7. UNIT
	7.1 Low Speed Shafts	34
	7.2 The Mounting of the Protection Caps	34
	7.3 Torque Arm	35
	7.4 Dimensions	36
	7.4.1 PAM B5 Dimensions	37
	7.4.2 PAM B14 Dimensions	37
	7.5 Worm Gearmotors and Reducers with Torque Limiter	38
	7.5.1 Torque Adjustment	38
	7.6 PMRL PLUS Versions	38
	7.7 Backstop	39
	THE ELECTRICAL MOTOR AND BRAKE CONNECTION	8. UNIT
	8.1 The Electrical Motor and Brake Connection	40
	8.2 The Electrical Motor Connection Schema	41
	8.3 Standard Type Brake Anchorage Schema	42
	TROUBLESHOOTING	9. UNIT
	9.1 Product Disposal	43
	9.1.1 Disposal	43
	9.2 Troubleshooting	44 - 47
	AUTHORIZED SERVICE	10. UNIT
	10.1 Authorized Service	48
	CONTACT INFORMATION	11. UNIT
	11.1 Contact Information	49



► List of illustrations

Figure 1 :	Transport of Gearboxes	9
Figure 2 :	Gearbox Nameplate and Explanation	11
Figure 3 :	Activation of Vent Plug	17
Figure 4 :	The Mountage of the Connection Tool to the Output Shaft	18
Figure 5 :	The Mountage of the Coupling	18
Figure 6 :	The Demountage of the Electrical Motor (PAM)	19
Figure 7 :	Mounting Positions	23
Figure 8 :	Output Solid Shaft	34
Figure 9 :	Protection Cover	34
Figure 10:	Torque Arm	35
Figure 11:	Input Shaft (PRV _{PLUS+})	36
Figure 12:	Input Shaft (PRV _{PLUS+} / PMRV _{PLUS+})	36
Figure 13:	PAM B5	37
Figure 14:	PAM B14	37
Figure 15:	Torque Limiter	38
Figure 16:	The Electrical Motor Connection Schema	41
Figure 17:	Standard Type Brake Anchorage Schema	42







► List of tables

Table 1 :	Safety Alerts and Information Signs	5
Table 2 :	Product Description (PMRV _{PLUS+})	12
Table 3 :	Product Description (PRV _{PLUS+})	12
Table 4 :	Abbreviations	13
Table 5 :	Critical Applications (Speed Control)	15
Table 6 :	Bolt Tightening Moments	17
Table 7 :	Control and Periodic Maintenance Ranges - Works	20
Table 8 :	Oil Plugs Squeezing Torc Chart	22
Table 9 :	Mounting Positions (M1)	24
Table 10:	Mounting Positions (M2)	25
Table 11:	Mounting Positions (M3)	26
Table 12:	Mounting Positions (M4)	27
Table 13:	Mounting Positions (M5)	28
Table 14:	Mounting Positions (M6)	29
Table 15:	Terminal Box and Cable Entrance Sides (PMRV _{PLUS+} / PRV _{PLUS+})	30
Table 16:	Terminal Box and Cable Entrance Sides (PMRV _{PLUS+} / PRV - PPC _{PLUS+})	31
Table 17:	Lubricant Fill Quantities (PMRV _{PLUS+})	32
Table 18:	Lubricant Fill Quantities (PPC)	32
Table 19:	Lubrication Table	33
Table 20:	Output Solid Shaft	34
Table 21:	Input Shaft (PRV _{PLUS+})	36
Table 22:	Input Shaft (PRV _{PLUS+} / PMRV _{PLUS+})	36
Table 23:	PAM B5	37
Table 24:	PAM B14	37
Table 25:	Torque Limiter	38
Table 26:	Disposal Table	43
Table 27:	Troubleshooting	44 - 47
Table 28:	Authorized Service	48

1.1 Important Warnings

Take into consideration the listed safety warnings and information signs below!

Table 1: Safety Alerts and Information Signs

	ATTENTION ! Dangerous position and possible result Slight and unimportant woundings
	NOTE ! Advices and necessary informations for the user
	DANGER ! Harmful position and possible result Damage in gear unit and environment
	DANGER OF ELECTRICITY ! Danger of electrical shock and possible result Death and heavy woundings
	DANGER ! Danger possible result Death and heavy woundings



1.2 General Information

This user guide is prepared by our firm to provide information about safety transportation of gear unit/gear unit with motors, storage, installation/mounting, connection, operating, maintenance and repair processes. All the purchase and technical data are positioned at product catalogues. Beside engineering applications, the information which is placed in this instruction, should be well read and applied. The documents must be protected and to get ready for controlling by authorized person. The information about electrical motor could be found by guidance which is prepared by motor-producing firm.

1.3 Correct Use

NRW The products are designed to use in commercial plants and are operated convenient to the current standards and directions. Technical data and allowed usage conditions are placed in product's power tab and usage guidance. Should be conformed to all the values.

This usage guidance is prepared by our firm according to 2006/42/EC The European Union Machinery Safety Instructions and is not to be placed 2014/34/EU "The direction about tools used in possible explosive environment and protective systems".

1.4 Safety Information

In gear units /gear units with motors and motors, there could be pieces subjected to voltage, movable pieces and hot areas. During all the works to be done; transportation, storage, placing, mounting, connection, operating, maintenance-repair processes could be implemented by qualified employees and responsible managers.

All the processes to be implemented during the working period;

- Related usage and maintenance instructions
- Warning and Safety Tags in gear unit/gear unit with motor
- Instructions and Requirements related to the system
- Local and International requirements for safety and accidental protection

Our Firm is not responsible where the listed items are implemented below:

- Violation of work health and safety rules in gear unit/gear unit with motors,
- Improper usage (The usage which is stated out of bounds in guidance and all the usages except tag/catalogue values especially usage in high moment and different cycle) and mismounting and misuse of gear unit/gear unit with motor in plant,
- Extremely dirty and maintenance free of gear unit/gear unit with motor,
- Unlubricated usage,
- Usage of product other than out of tag/catalogue values,
- Wrong motor selection,
- Take out of the necessary protective plugs,
- Disuse of original pieces in gear unit/gear unit with motor,
- The using, mounting, maintaining and taking place of the uneducated, unauthorized and unqualified persons.

1.5 Responsibility

NRW, declines any responsibility in case of:

- Use of the reducer not compliant with national laws on safety and accident prevention,
- Work done by unqualified personnel,
- Incorrect installation,
- Tampering with the product,
- Incorrect or failure to follow the instructions in the manual,
- Incorrect or failure to follow the indications marked on the identification labels fixed on the units,
- For motor gearboxes, wrong delivery of electrical power,
- Incorrect connections and/or use of temperature sensors (when present),
- Use of gearbox under unlubricated conditions,
- The contents of this manual were reviewed to ensure consistency with the catalogues and etc. documents. We cannot guarantee full consistency since the changes cannot be completely prevented. However, the informations in this manual are reviewed regularly and necessary revisions are made in next editions.

The products supplied by NRW are intended to be incorporated into "complete machines", so it is prohibited to put them into service until the entire machine has not been declared compliant.



ATTENTION !

The configurations provided in the catalogue of the unit are the only ones allowed. Do not use the product in contrast with the indications provided in it. The instructions provided in this manual do not replace but compensate the obligations of current laws concerning safety regulations.

1.6 Transportation

1.6.1 Transportation and Freightage;

- Take into consideration of the article stated on package during the product delivery.
- During the delivery, product should be controlled about possible damages in carrying period.
- The firm should be informed about possible damages.
- The damaged products should not be put into use.
- If there are 2 lifting flanged eyebolts in gear unit with motor, both of them could be used in carrying process upon the size of gear unit and motor. In necessary situations, the suitable and adequate-size carrier should be used.
- Carrying safeties should be removed before the start of operating.
- The weights of the movable gear units/gear units with motors are placed in product catalogues.
- The dangerous area should be got into the secure to prevent damage to the persons.
- During the carrying process, to stand under the gear unit could cause danger of death.
- The damage of gear unit must be prevented. The crushes to the free input shafts could damaged into the gear unit.

1.6.2 Package Transportation;

- There could be no loads on packages or the shelved surfaces should be prepared.
- The necessary carrying equipments should be prepared.
- The carrying and lifting equipments should be larged - enough to the sufficient capacity.
- The calculations should be made to the connection points and center of gravity.
- If necessary, this information should be written on the package.
- The carrying equipments (steel rope, belt, chain etc.) must be robust and suitable to the applied weight.
- During the carrying process, the load centering could be done without oscillation.



1.6.3 Equipment Transportation;

- The connection carrying point should be appointed.
- The carrying equipments (hook, chain, belt) must be prepared. To the alternative, pallet must be used for the load - lifting.
- If the Crane will be used, it could be lifted perpendicular from inside to the outside of the package.
- If the forklift or palletized carrying equipment will be used, the product which removed from package should be placed on the pallet.
- The fork of the equipment should be carried out the way that gripped the pallet.
- The weight must be lifted both with slowly and constant speed and must take measure to the sudden oscillation.



ATTENTION !

During the carrying process, the fixings like the lifting lug, hook, belt, rope, locked hook must be sufficient to the load and have conformity certificate. The weights of the movable gear unit/gear unit with motor have given in product catalogue.



NOTE !

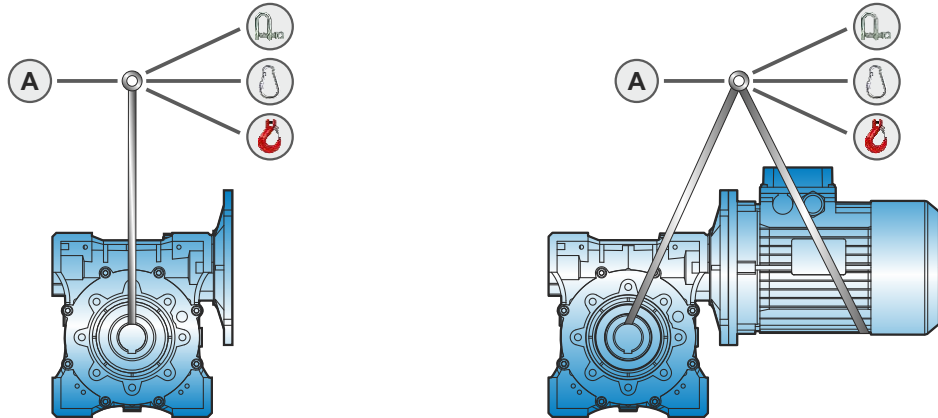
In all carrying processes, there should be avoided from both sudden movements and sudden liftings.



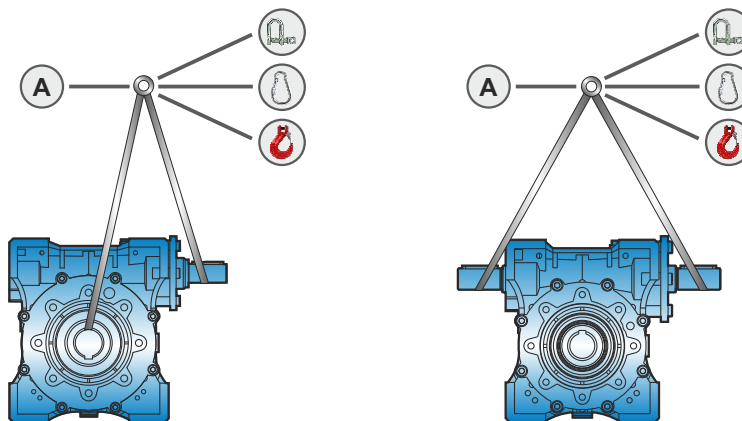
1.6.4 Transport of Gearboxes;

Figure 1: Transport of Gearboxes

PMRV
PLUS+



PRV / PRV-VS
PLUS+ PLUS+

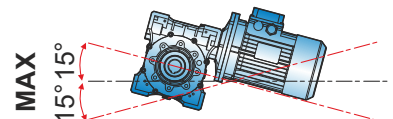


- Hoop equipped (swab)
- Load hook
- Screw hook
- Locked hook

Manuel lifting (Weight ≤ 15 kg)
(ref. ILO Contract)
Not valid for the continuous carrying.



The allowable maximum slope is 15 degree.





1.7 Storage

The certain suggestions have given about the storage conditions of the gear unit/gear unit with motor below;

- In clear and moist-airs, the storage should not be made.
- The gear unit/gear units with motor should not directly be contacted to the ground.
- The place must be moveless where the both gear unit/gear units with motors are contacted. Otherwise there could be damage during the movement.
- The gear unit should be got into the secure to the falling.
- The processed surfaces of the gear units and both solid and hollow shafts must be lubricated with protective oil.
- Gear unit/Gear units with motors must be in the place where there will be no big temperature differences between 0°C and 40°C.
- Relative humidity must be less than %60.
- Not directly be exposed to sunlight and infraded light.
- Must be kept away from the abrasive materials which causes corrosion (dirty weather, ozon, gases, solvents, acids, salts, radioactivity, etc.) in environment.
- The protective oil SHELL ENSIS or similar product should be used on the corrodible pieces.
- If the gear unit is without oil, it must be filled with lubrication oil.

1.7.1 Long Term Storage Suggestions;

	<p>NOTE !</p> <ul style="list-style-type: none"> - In the long-term storage or during the short-term storage, if the excessive temperature differences occur, the oil in the gear unit must be changed before the operating. - In the fully oil filled gear unit, the oil level should be reduced according to the mounting position.
	<p>ATTENTION !</p> <ul style="list-style-type: none"> - The incorrect and excessive long storage could cause the gearbox getting defected. - Please control not to exceed allowed storage period before starting up the gearbox.
	<p>NOTE !</p> <ul style="list-style-type: none"> - NRW, recommends long-term storage option for periods of more than 9 months holding and pausing times. - By paying attention both to the long-term storage option and precautions which listed below, the holding of goods up to 2 years could be possible. Because of real efficiency of gearboxes depending on local conditions widely, these periods could be seen solely guide values.

Long term storage suggestions;

- Synthetic oil according to mounting position is filled of getting available for operating. Despite this, the oil level should be controlled before operating.
- The VCI Corrosion protected tool are mixed into the gear unit's oil.
- The carrying safety of the ventilation plug must not be removed during the storage.
- The gear unit must be closed to the shape of unleaked.



2.1 Gear Unit Label

Important technical informations are found on gearbox's label.

Figure 2: Gearbox Nameplate and Explanation

NRW [®] DRIVE TECHNOLOGIES		☎: 0049 23828557010 www.nrwdrivetechologies.com	
Type:	①		
			②
Serial No:	③		
M ₂ :	④	Nm	i: ⑤
P ₁ :	⑥	kW	n ₂ : ⑦ min ⁻¹
f _B :	⑧	🏋️ ⑨	kg
🛢️ ⑩			📖 i
IN DER SCHLINGE 6, D-59227 AHLEN / GERMANY			

- ① Type
- ② Mounting position
- ③ Serial number
- ④ Output torque (Nm)
- ⑤ Reduction ratio
- ⑥ Rated power of motor [kW]
- ⑦ Output speed [d/dk]
- ⑧ Service factor
- ⑨ Weight of the geared motor (kg)
- ⑩ Used oil kind and amount (Lt)



2.2 Explanations

Table 2: Product Description (PMRV PLUS+)

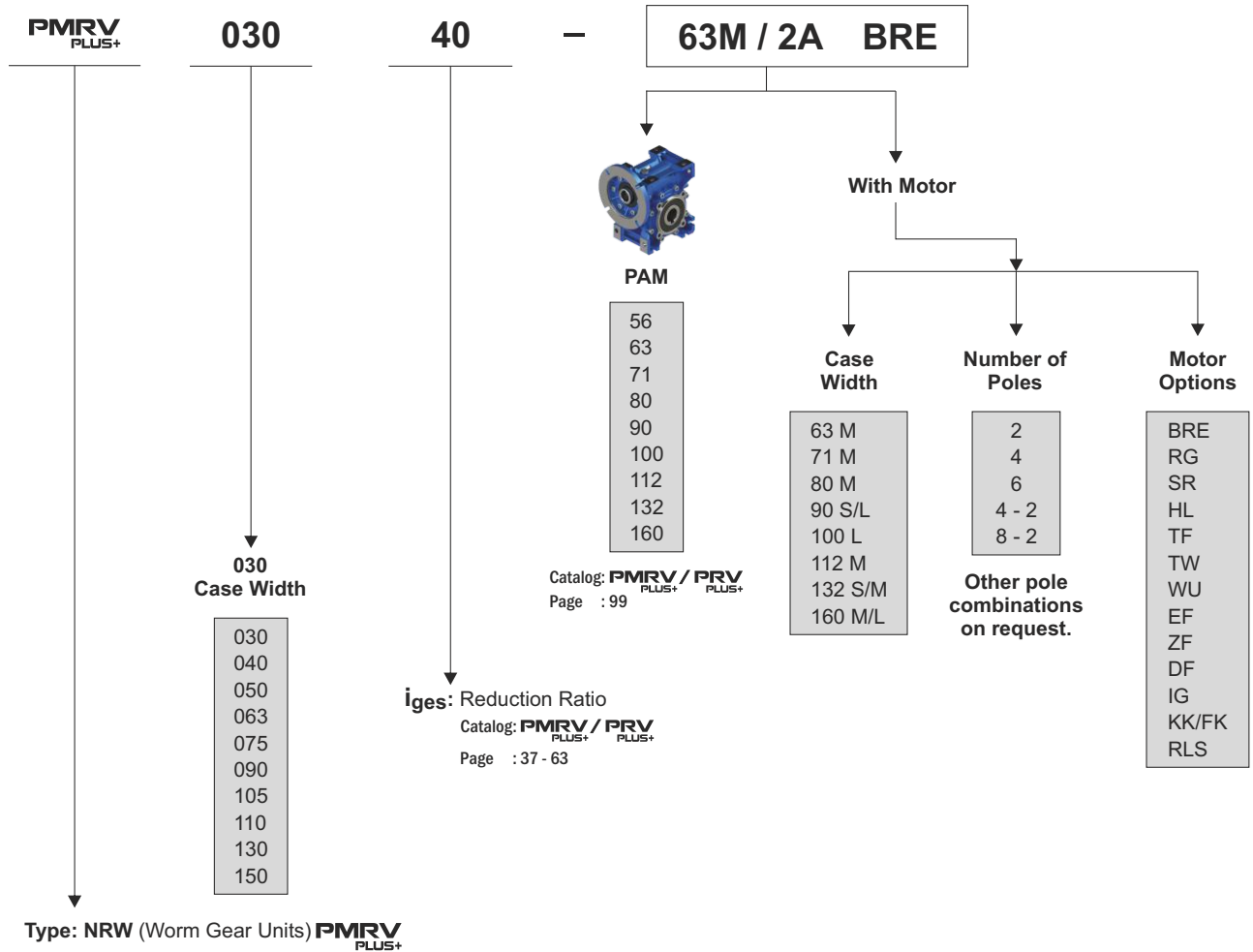
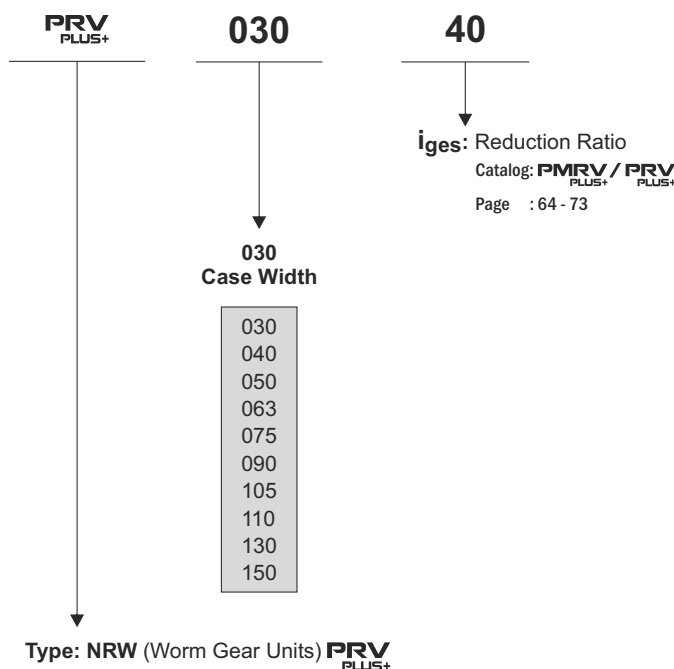


Table 3: Product Description (PRV PLUS+)





2.3 Abbreviations

Table 4: Abbreviations

Abbreviations	Meaning	Worm Gear Units
FA - FB - FC FD - FE	Output Flange	✓
PAM	PAM B5 - B14 Adapter	✓
TK	Torque Arm	✓
KK	Protection Cover	✓
AB	Double Output Shaft	✓
B	Backstop	✓
AS	Single Output Shaft	✓
VS	Double Input Shaft	✓

✓ : Existing designs are marked with a tick.



3.1 Prerequisites of Assembly

Take into the consideration which listed below;

- The informations placed on gear unit with motor in accordance with current network voltage.
- There could be no damage in the gear unit.
At standard gear units;
- The ambient temperature should be fitted temperature values given in the "Lubricant" part.



DANGER !

The Gear unit must not be mounted in the ambient conditions listed below:

- Explosive atmosphere, high corrosive and/or oils, acids, gases, steams, radiation,
- Places directly contacted to the food.

At special applications the configuration of gear unit/gear unit with motor are realized convenient to the ambient conditions. Output shafts, processed surfaces, corrosion preventive material on the solid shaft/hallow shaft, jerks etc. must be cleaned.

Extensive usage-solvent must be used. The solvent should not be contacted to the bearing houses and sealing components.

In the abrasive ambient conditions, both output shaft, sealing components must be protected to the wearing Connection flanges must be attached to the hollow shaft/solid shaft according to DIN 332.

The situations where the wrong direction of rotation could caused to damages and dangers, before the mounting, the test work should implemented to the gear unit so the right direction of rotation could be determined and must got into the secure for the next operating.

In the one-way locked gear units, nibs are placed at the entry and exit side of the gear unit. The ends of the nibs shows the direction of rotation of the gear unit. During the motor connection and motor-operating with the help of magnetic field, the gear unit must be operated just at the direction of rotation.



DANGER !

In the one-way locked gear units, the gear unit must be operated at the direction of lock rotation, otherwise the damage could be occurred.

Around the mounting position, there must be sured that there are not any materials fused to metal, lubricating tool or elastomers which causes corrosion or will not be emerged.



3.2 Critical Applications

The performance given in the catalogue correspond to mounting position B3/M1 or similar, ie. when the first stage is not entirely immersed in oil.

For other mounting positions and/or particular input speeds, refer to the tables that highlight different critical situations for each size of reduction unit. It is also necessary to take due consideration of and carefully assess the following applications by calling our Technical Service:

- As a speed increasing.
- Use in services that could be hazardous for people if the reduction unit fails.
- Applications with especially high inertia.
- Use as a lifting winch.
- Applications with high dynamic strain on the case of the reduction unit.
- In places with T° under -5 °C or over 40 °C.
- Use in chemically aggressive environments.
- Use in a salty environment.
- Mounting positions not envisaged in the catalogue.
- Use in radioactive environments.
- Use in environments pressures other than atmospheric pressure.
- Avoid applications where even partial immersion of the reduction unit is required.

The maximum torque;

(*) that the gear reducer can support must not exceed two times the nominal torque ($f_B=1$) stated in the performance tables.

(*) intended for momentary overloads due to starting at full load, braking, shocks or other causes, particularly those that are dynamic.



Table 5: Critical Applications (Speed Control)

PMRV PLUS+	063	075	090	105	110	130	150
V5: 1500 < n1 < 3000	-	B	B	B	B	B	B
n1 > 3000	B	B	A	A	A	A	A
V6	B	B	B	B	B	B	B

A : Application not recommended.

B : Check the application and/or call our Technical Service.



3.3 Gear Unit Mounting

The lifting eyebolts screwed to gear unit must be used in gear unit mounting.

- Mounting of gear unit/gear unit with motor to the machine and selection of mounting place are crucial.
- The convenient connection points must be determined for gear unit type. (Foot mounted or Flange mounted)
- Ventilation plug must be opened after the carrying process.
- The connection tools which attached during the mounting to the machine must be tightened convenient to the torc given at the table.
- Because of the voltage, for to avoid transferring additional forces to the gear unit, both the gear unit and driven machine shaft must be aligned.
- There should not be any welding process on the gear unit. In the welding processes, the gear unit must not be used as a bracket. Otherwise bearing and gear part could damaged.



ATTENTION !

During the mountage, the voltage should not be emerged between the foot and flanges and allowed radial and axial forces would not be taken into consideration! Check whether if there is radial or axial leakage at the connection unit which is between PAM and output shaft.

- The gear unit/gear unit with motor only could be mounted according to determined mounting position. After the delivery, in the case of changing mounting position the change of lubrication level and other precautions could be needed. Any failures to comply to the determined mounting position could damaged gear unit.
Please consult to NRW.
- The gear unit/gear unit with motor have to be structured to stand against motor weight and operating voltages. The machine which will be connected has to be structured to stand against the weight of the gear unit with motor and operating voltage. The surface where the gear unit is to be fixed must be straight, vibrationless and protected against torsion.
- The machine which gear unit/gear unit with motor will be connected, there must be sured that it is closed and not to be operated without intention.
- The sphere of the movable pieces out of the gear unit must be closed with the safety cabinet kit.
- The sunlight and the impact of the weather conditions must be prevented during the mountage of the gear unit to the outside machine. However the air circulation needed to be provided to the unit.
- Depending on the type of used gearbox, all the foot and flange bolts must be used completely. Bolts must be tightened with proper tightening moments.



NOTE !

The opportunity of the easy access must be provided to the oil level plug, drain plug and ventilation plug.

The proper oil filling should be controlled according to mounting position. (Could be viewed on 'lubricators/oil filling quantities' part or the values written on gear unit) The necessary amount of oil has filled to the gear unit/gear unit with motor by our firm. The slight deviations in oil level plug are resulted because of the mounting position and within the production tolerances.

If there is any danger of the electro-chemical corrosion between gear unit and machine, plastic pieces (2-3 mm) must be mounted between the connections. The electrical discharge resistance of used plastic material must be <math>< 10 \Omega</math>.

Electro-chemical corrosion could be occurred between the different metals like cast iron and stainless steel. Also plastic washer should be used in bolts!



3.4 Bolt Tightening Torque Value

Table 6: Bolt Tightening Moments

Bolt Tightening Moments [Nm]						
Dimensions	Bolt Quality			Cover Bolts	Coupling Bolts	Protective Cover Connection Bolts
	8.8	10.9	12.9			
M4	3.2	5	6	-	-	-
M5	6.4	9	11	-	2	-
M6	11	16	19	-	-	6.4
M8	27	39	46	11	10	11
M10	53	78	91	11	17	27
M12	92	135	155	27	40	53
M16	230	335	390	35	-	92
M20	460	660	770	-	-	230
M24	790	1150	1300	80	-	460
M30	1600	2250	2650	170	-	-
M36	2780	3910	4710	-	-	1600
M42	4470	6290	7540	-	-	-
M48	6140	8640	16610	-	-	-
M56	9840	13850	24130	-	-	-
G½	-	-	-	75	-	-
G¾	-	-	-	110	-	-
G1	-	-	-	190	-	-
G1¼	-	-	-	240	-	-
G1½	-	-	-	300	-	-

3.5 Gear Unit Ventilation

The ventilation plug is used in PMRV PLUS / PRV PLUS 110-130-150 body types.

In moist places or in open air usage, the gear unit which is resistant to corrosion is recommended. The damages in paint (in ventilation plug) must soon be corrected.

The carrying safety of the ventilation plug on the gear unit is to be remove. If ventilation plug was sent separately, it has to be inserted.

Figure 3: Activation of Vent Plug



1. The carrying secured ventilation plug,
2. Remove the carrying safety,
3. The ventilation safety is active.



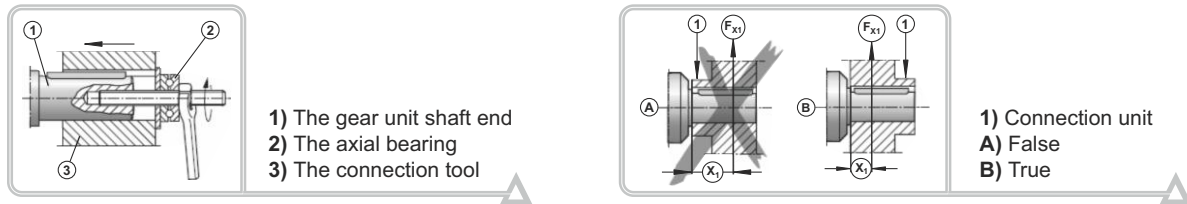
3.6 Retrospective Paintwork

If you paint over all or part of the drive, please take care to mask the breather valve and oil seals carefully. Remove the masking tape once you have completed the painting work.

3.7 The Mountage of the Connection Tool to the Output Shaft

For the mountage of the output shaft tools look at the schema below.

Figure 4: The Mountage of the Connection Tool to the Output Shaft



* To prevent high radial forces: the gear and sprocket must be mounted as seen in shape B.

For the mounting of the connection tools only pulling device must be used. For the position adjustment the bearing strip which is at output shaft end must be used.

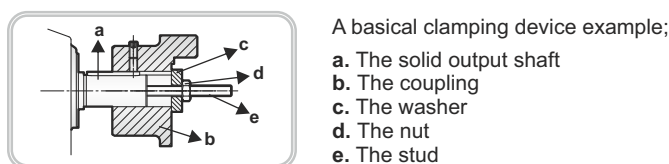
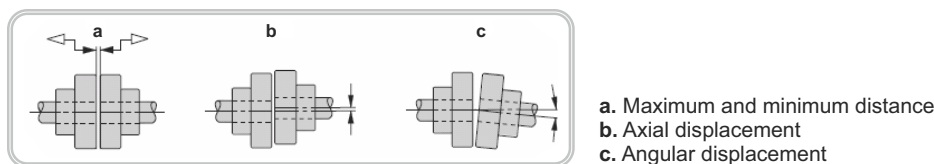
	<p>NOTE !</p> <p>The belt and pulleys, couplings, gears and etc. Must not be installed with hammering to the shaft end. Otherwise there could be a damage in body, bearings and shaft. In belt and pulleys, the rightness of the belt voltage must be paid attention. (suitable to the producer's data). For the not emerging of disallowed radial and axial forces, balance adjustment of the connection tool must be made.</p>
--	---

	<p>NOTE !</p> <p>With smearing a little amount of grease or heating the connection tool in a short-time (80....100 °C), the mounting easiness may be provided.</p>
--	---

3.8 The Mountage of the Couplings

While the couplings are mounting, it's balances must be made suitable to the datas of the producers. Must be implemented with suitable clamping device. Before mounting with the smearing of corrosion oil material to the solid output shaft/hollow shaft, mounting and demounting processes may be eased.

Figure 5: The Mountage of the Coupling



	<p>ATTENTION !</p> <p>The belt-pulley, chain and gear drives must be protected from the contact of the external effects.</p>
--	---



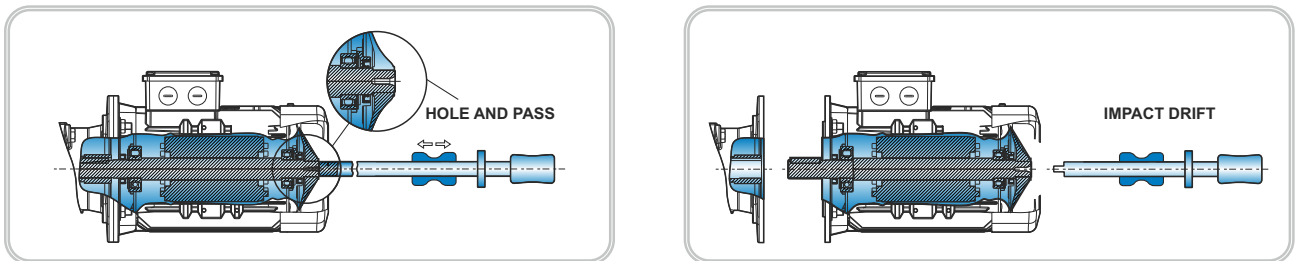
3.9 The Mountage of the Standard B5 Motor to the PAM Gear Unit

1. The motor and the solid output shaft of the motor with PAM adapted, flange surfaces must be cleaned and damage control must be made. The sizes and tolerances of the motor fixing elements must be suitable to EN 60079-0.
2. Must be pushed till to stand to the block of motor solid output shaft.
3. If the mountage is to be done in open air and the environment is wet, it is recommended that the surfaces of the motor flange and PAM adaptor have to be isolated. Before and after the motor mounting, in the shape of flange is isolated, loctite 574 or loxeal 58-14 surface isolation material should be used to flange surfaces.
4. The motor, must be installed to PAM adaptor.
5. The bolt of the PAM adaptor has to be mounted with suitable tightening moment.

3.10 The Demountage of the Electrical Motor (PAM)

During the operating, it is crucial that the surface of the connection tool between the motor and gear unit is not rusted, for the removal of the motor not to exercise excessive load is necessary. During the separation of motor from the gear unit without forcing, the method at the below must be implemented. Must be avoided the implementations that causes strain and harm to the gear unit.

Figure 6: The Demountage of the Electrical Motor (PAM)



1. By fan with drilling the motor solid output shaft, the thread cutting must be opened.
2. The impact drift has to be installed to the threaded place.
3. The connection screws between the motor and gear unit must be removed.
4. By the help of impact drift inertial force, the motor must be separated from the gear unit.

The use of slots in the body of PAM, with the help of screwdriver or lever in a way that the motor is not harmed, may be removed by pushing back.

3.11 Gear Unit Operating

- The gear unit is tested firstly at our firm. (leakproofing test, noise test, torc test)
- For the confirmation of direction of rotation of gear unit, it is needed to be operated before machine mounting.
- The mounting of gear unit to the machine is needed to be convenient to 2006/42/EC and other safety standards.
- The electrical motor is needed to cover EN 60204-1 and EN 60079-0 standard.
- The mounting position of the gear unit should be as same as tag values.
- The datas in power units should be tolerated (plus, minus) %10 according to values specified in tag.
- There must not be any oil leakage in gear unit.
- There must not be extremely vibration and must not exceed acceptable voice decibel for gear units.
- In the situation of long-term non-usage, the storage conditions are needed to be implemented.
- The oil position must be controlled for the mounting position specified in catalogue.
- The oil level must be controlled.
- Before the operating, the carrying safety of the ventilation plug on the gear unit is needed to be removed.
- If the gear unit is dispatched without oil, the first oil filling must be loaded according to oil quantity stated in oil tables.
- It is not allowed to operate in sensitive areas against explosion. For these conditions, specific motors are available. Please consult to our firm.



4.1 Control and Periodic Maintenance

	<p>NOTE !</p> <p>The maintenance and periodic maintenance works are performed by qualified person/ operator who is well-educated and is sufficient in electric and mechanic issues; the rules convenient to job health and safety and specific environmental problems are performed as protected.</p>
--	--

	<p>DANGER !</p> <p>Before the start of the maintenance work of the gear unit, gear unit should be closed at first (get into the voltage-free position), be sured service-free, needed to take measures against any accident or spinning items with the help of unexpected external load. Also all environmental safety precautions must be taken.</p>
--	--

- Before the maintenance process, all safety equipments are needed to get ready and if necessary the outside personal should be warned. The border around the unit must be specified and must prevented equipment entrance to the area. If any failures to comply to these conditions, the situations which causes harm to health and safety could be occurred.
- Worn items only must be changed with original and unused items.
- The lubricators ,which recommended by our company, should be used.(see. **6.3 Lubrication Table**, page 33)
- The leakproofing items on the gear unit must be changed with original items.
- If the bearing is needed to be changed please contact to our firm.
- After the maintenance work, we recommend to change the lubrication oil.

All above informations were given for the purpose of efficient and confidential operating of gearboxes. Our firm is not responsible for substitute product and unroutined maintenance that causes damages and woundings.

When purchasing gear unit,should be noted that it is original product and has technical informations written in catalogue.

	<p>NOTE !</p> <p>The polluted oil and rusted items must not be left to the environment after the maintenance. These items must be disposed convenient to the regulations.</p>
--	--

Table 7: Control and Periodic Maintenance Ranges - Works

Control and Periodic Maintenance Ranges	Control and Periodic Maintenance Works
Once at every 3000 work hours or once at every 6-months until the	<ul style="list-style-type: none"> - Visual inspection - Check for running noises - Check oil level
80 work heat. Once at every 10.000 work hours or once at least in two years (the synthetic oil is once at every 20.000 work hours or once at every four years)	<ul style="list-style-type: none"> - Change the oil - The change of the ventilation plug
At least every 10 years	<ul style="list-style-type: none"> - General overhaul.



4.2 Visual Inspection

Controlling whether there is any oil leakage exists or not should be made at gearbox.

There must be controlled that if there is oil filled or not in gear unit. Should be controlled that if there is any damage in gear unit's items and whether if the connection spots are rusted.

Also must be controlled that if any cracks could emerge in hose connection lines and in rubber wedges.

Leakproofing likes of dripping of gear unit's oil or dripping of cooling water and in damages and cracks, repair of the gear unit must be provided. Like these situations please get in contact with NRW.

Because of the storage and carrying, before the operation of gear unit and during at first operation, low amount of grease could flow out from bearing, this type of oil leak could not create any technical failure, the safety of gear unit and bearing operation could not be effected.

4.3 Check for Running Noises

The emerge of unusual operation voice or vibrations in gear units could mean damages. In this type of situations, the gear unit must be stopped and overall revision must be made.

4.4 Control of the Lubricant and Lubricant Level

- Regular oil level controlling must be made.
- The electrical connection of motor must be cut and must got into safety form to prevent for reactivating.
- Must be waited until the gear unit got cooled.
- If the mounting position is changed, the section of "the mounting of gear unit" must be got into attention.
- A little amount of oil must be taken out of the oil drain plug. The quality of oil must be controlled.
- The oil must be changed when the sign of extremely oil pollution is seen.

	NOTE !
	PMRV PLUS / PRV PLUS 030...105 The oil changing is not required through usage of these gearbox types. There are not any oil level plugs at these gearboxes, therefore oil level would not be controlled.

4.5 Changing the Oil

To prevent the emergence of the danger of burning, must be waited until the gear unit got cooled. The oil level, draining and position of ventilation plugs are dependent on mounting position. For the mounting position, related pages from catalogue could be seen. When the oil-changing process, the gear unit should be at operating temperature. The electric connection of motor driving unit must be cut and got into safety for re-activation.

	NOTE !
	Because of the coldness of oil will affected the flowing and venting, the gear unit must not be cooled fully.

Changing the oil;

- Oil level plug, oil draining plug and ventilation plug must be removed.
- The leakproofing elements on gear unit must be changed with original items.
- The oil draining plug must be put back to it's own place again.
- The oil according to mounting position must be filled from the vent hole with the proper draining device to the amount which is shown in catalogue. (could be filled from hole which is on the oil level). If the oil type is changed. Must be consulted to our firm.
- 30 minutes after the oil filling, oil level must be controlled.

At high temperatures or at hard working conditions (high humidity, corrosive environment or high temperature fluctuations), the oil changing ranges must be reduced by half.



4.6 Oil Plugs Squeezing Torc Chart

Table 8: Oil Plugs Squeezing Torc Chart

Plug	Torc [Nm]
1/4"	7
3/8"	7
1/2"	12

4.7 Change of the Ventilation Plug

In excessive pollution situations, ventilation plug must be dismantled and got cleaned or with aluminum washer, the new ventilation plug must be mounted.

4.8 Change of the Oil Seal and Oil Cover

- The electric connection of motor drive unit must be cut and got into safety for mistakenly re-activation.
- At the time oil seal is changing, the sufficient amount of grease must be found between leakproofing lips and should be paid attention that the surface is not dirty and dusty.
- When the double seal is used, 3/2 of the part which remained between two seal must be filled with grease convenient to the oil type inside the gear unit.
- During the change of the oil seal the proper devices must be used for not to harm the body and shaft.
- During the change of the oil seal and oil filler cup, the original product must be used.

4.9 The Bearing Greases

- To the bearings of motorized gearboxes, greases should be used which are available at the grease table given by our company.
- Our company (NRW) recommends also replacing of grease while changing lubricant at the greased bearings.

4.10 General Overhaul

The gear unit must fully be dismantled and works written below have to be done respectively.

- All parts of the gear unit must be cleaned.
- The damage control must be done to all parts of the gear unit.
- The damaged parts must be changed with original part.
- All roller bearings must be changed.
- If there are, locks must be changed.
- All oil seals and nilos caps must be changed.

All plastic and elastomer parts of the motor coupling must be changed.

	<p>NOTE !</p> <p>The general revision should be made by the qualified personnel with considering the international laws and regulations in the plants which has the required equipments. We recommend that the general revision has to be made at the NRW service.</p>
--	---

4.11 The Maintenance of the Motor

Our firm recommends to change the grease in greased bearings. Before the start of motor maintenance, the operator should closed the unit, must be sured that it is out of service and must taken all the measures against any accident or unexpected load.

- To prevent overheating, if there is, the dust coat on it must be cleaned.
- The bearings must be dismantled, cleaned and greased.
- Motor oil seals must be changed.



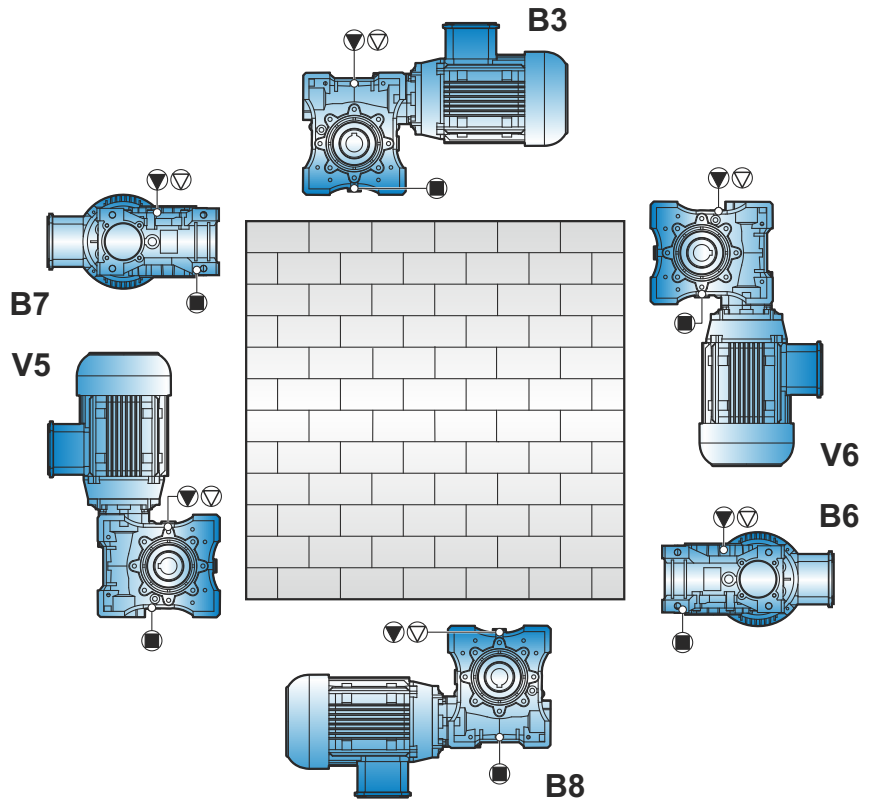
5.1 Mounting Positions

Install the gearbox at the projected moutage position. For the other moutage positions except this one, please consult to our Technical Service.

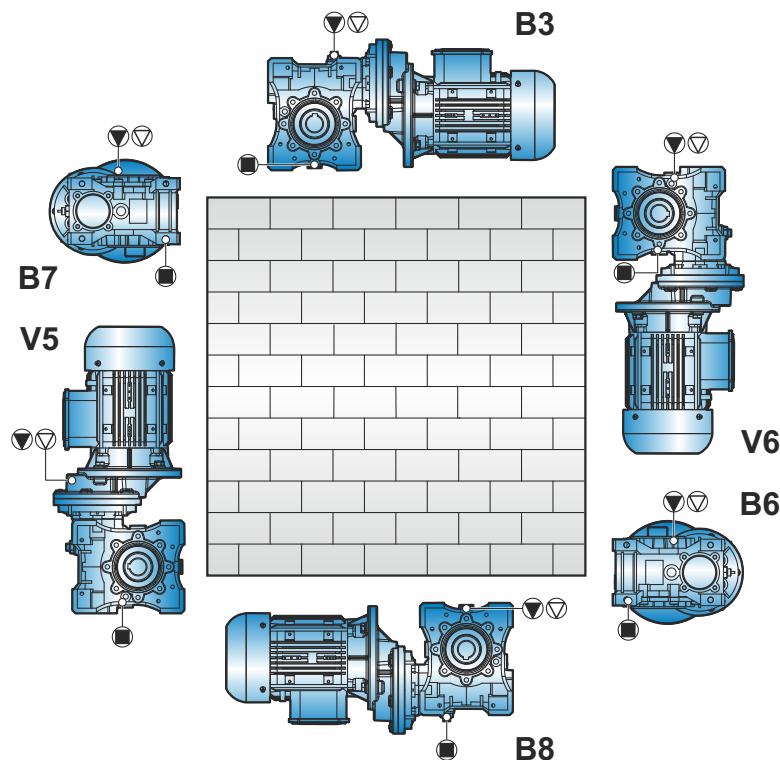
PMRV / PRV
PLUS+ PLUS+

Figure 7: Mounting Positions

PMRV / PRV PLUS+ PLUS+
030
040
050
063
075
090



PMRV / PRV - PPC
PLUS+ PLUS+



PMRV / PRV - PPC
PLUS+ PLUS+

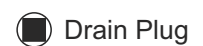
- 040 - 063
- 050 - 063
- 050 - 071
- 063 - 063
- 063 - 071
- 075 - 071
- 075 - 080
- 090 - 071
- 090 - 080



Filling Plug



Vent Plug



Drain Plug



PMRV - PMRV / PRV - PMRV - COMBI KIT
PLUS+ PLUS+ PLUS+ PLUS+

Table 9: Mounting Positions (M1)

M1			
M1 A	M2 A	M3 A	M4 A
M1 B	M2 B	M3 B	M4 B



Table 10: Mounting Positions (M2)

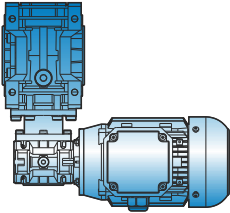
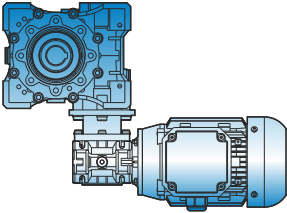
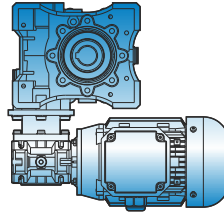
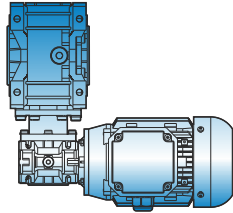
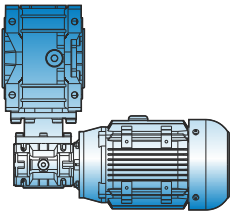
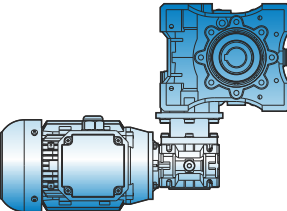
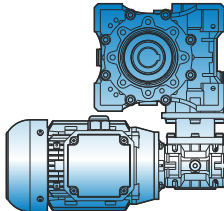
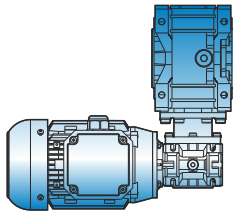
M2			
M5 A	M5 B	M5 C	M5 D
			
M6 A	M6 B	M6 C	M6 D
			



Table 11: Mounting Positions (M3)

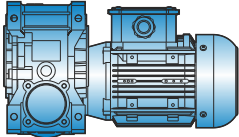
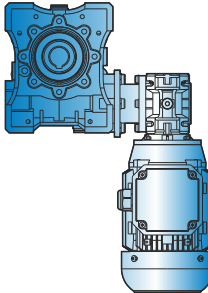
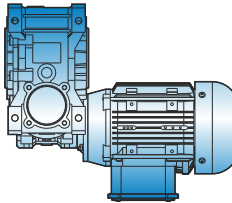
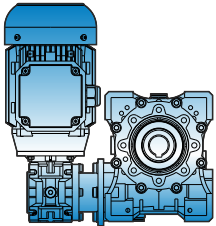
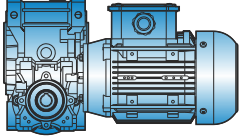
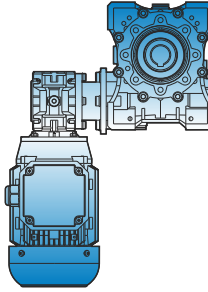
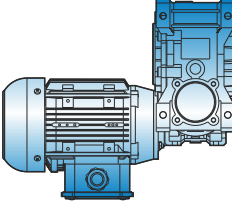
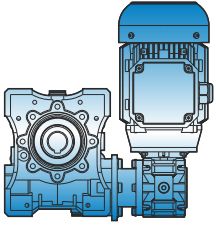
M3			
M1 A	M2 A	M3 A	M4 A
			
M1 B	M2 B	M3 B	M4 B
			



Table 12: Mounting Positions (M4)

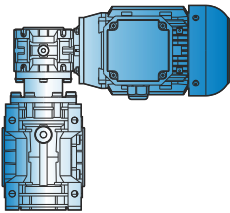
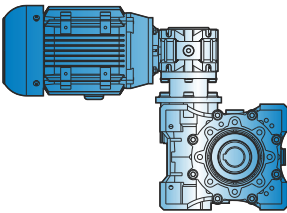
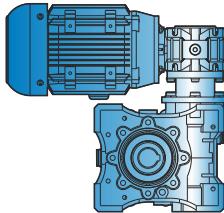
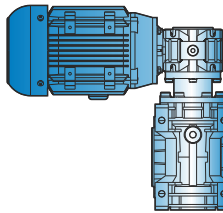
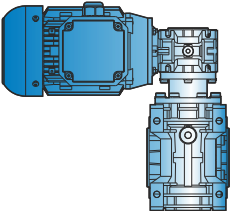
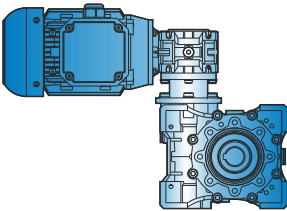
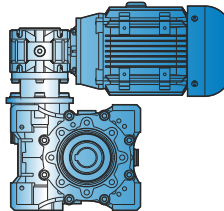
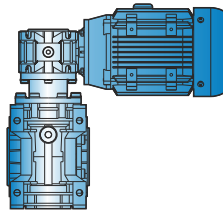
M4			
M5 A	M5 B	M5 C	M5 D
			
M6 A	M6 B	M6 C	M6 D
			

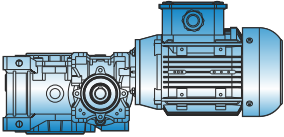
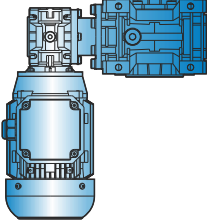
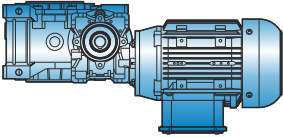
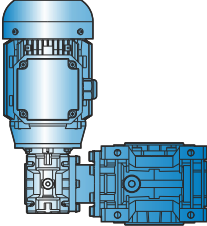
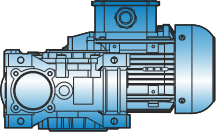
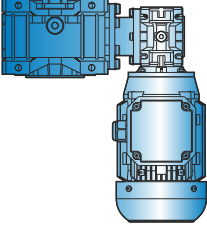
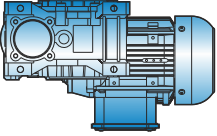
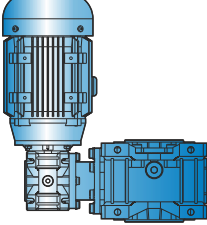


Table 13: Mounting Positions (M5)

M5			
M1 A	M2 A	M3 A	M4 A
M1 B	M2 B	M3 B	M4 B



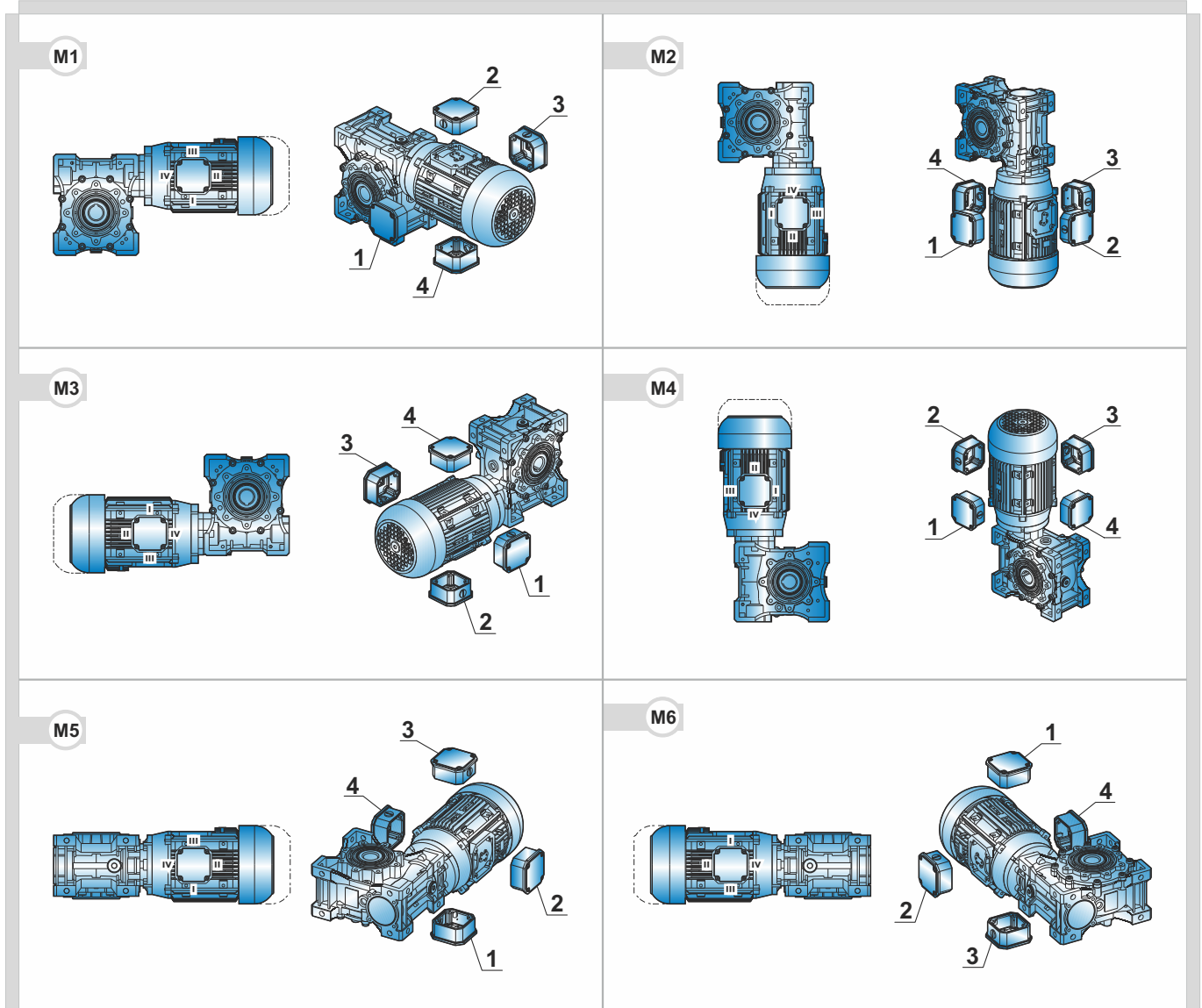
Table 14: Mounting Positions (M6)

M6			
M1 A	M2 A	M3 A	M4 A
			
M1 B	M2 B	M3 B	M4 B
			



5.2 Terminal Box and Cable Entrance Sides

Table 15: Terminal Box and Cable Entrance Sides (PMRV / PRV PLUS+ PLUS+)



* 1 - 2 - 3 - 4 : Shows terminal box position.

* I - II - III - IV: Shows cable entry position.

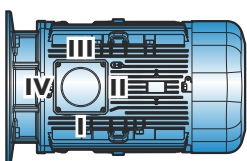
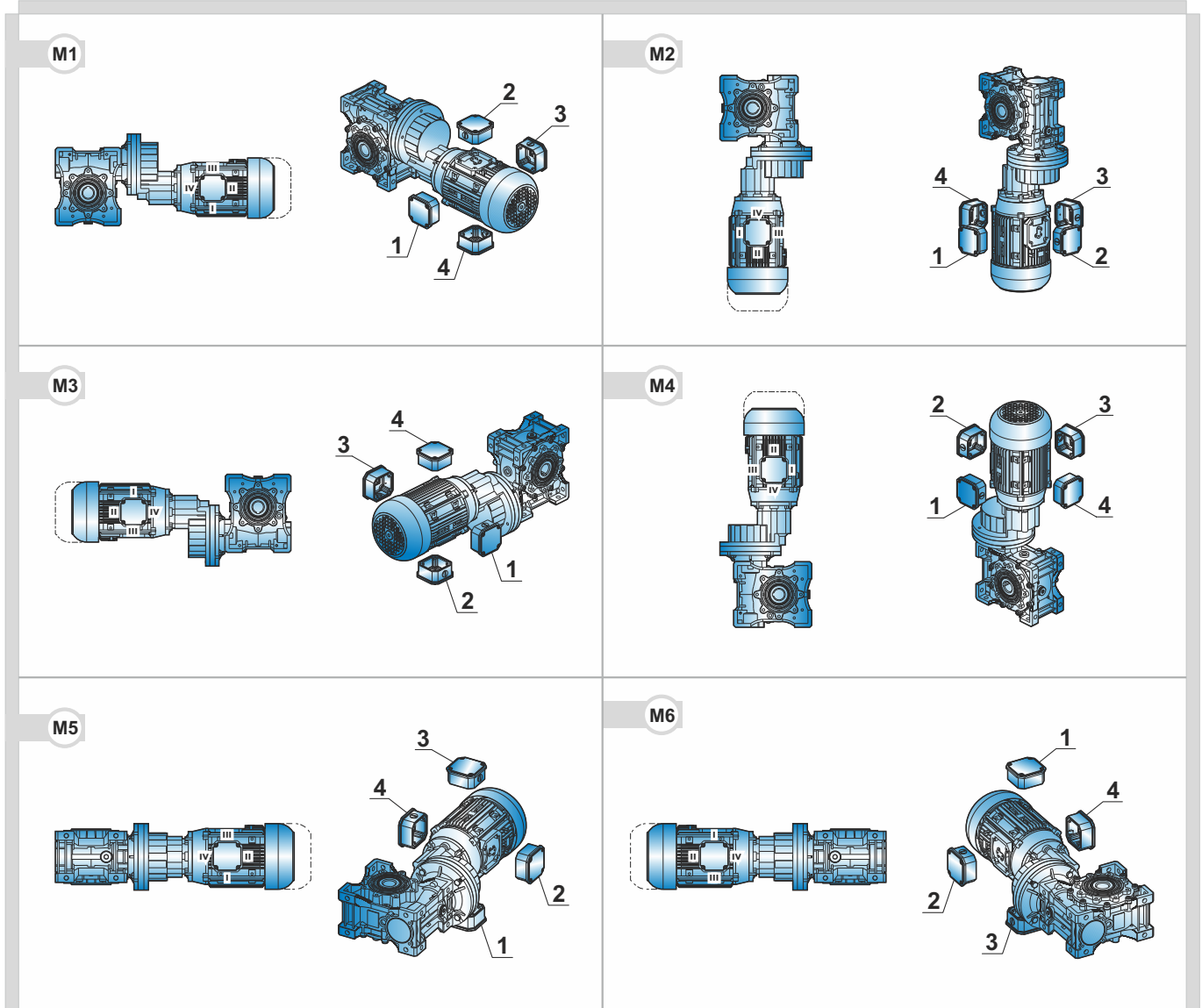


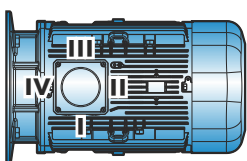


Table 16: Terminal Box and Cable Entrance Sides (**PMRV / PRV - PPC**)
PLUS+ PLUS+



* 1 - 2 - 3 - 4 : Shows terminal box position.

* I - II - III - IV: Shows cable entry position.





6.1 Lubrication

Before operating the gear unit, please check the oil level. If it is required, the same type of oil (shown on the label) should be added again (see oil table), when the gear unit is brought to the predetermined mounting position. In case it can not be used, please contact NRW Technical Service.

For possible use of different type of oils, replace the oil completely (after consulting NRW Technical Service). If synthetic oil will be used, it can be used after the oil in the gear unit has been drained and after the inside of the gear unit has been washed. For non-fat gear units, check the amount of oil that can be used and the amount required according to the working position from the additional namelabel and fill the required same lubricant on the product label according to the oil quantity table.

	DANGER !
	In the situations of not using the stated amount of oil out of the table the probability of emerging a damage at the gearbox could be high.

6.2 Lubricant Fill Quantities

	NOTE !
	The oil amount at the chart is only indicator and for filling correctly your consultation to oil level plug or oil gauge is required if either one exists. Any deviation at degree, generally related with construction tolerance, also could be changed depending to the placing of gearbox or moutage surface at the customer's working place. Therefore customer controls level when gearbox is set up and if necessary, restore level.

Table 17: Lubricant Fill Quantities (PMRV PLUS+)

PMRV PLUS+	063	075	090	105	110	130	150
B3					3	4.5	7
B8					2.2	3.3	5.1
B6 - B7	0.3	0.55	1	1.6	2.5	3.5	5.4
V5					3	4.5	7
V6					2.2	3.3	5.1

Table 18: Lubricant Fill Quantities (PPC)









PPC	063	071	080	090
B3 - B8				
B6 - B7	0.05	0.07	0.15	0.16
V5 - V6				






6.3 Lubrication Table

At below table, registered brands or names of goods have been showed according to gearbox lubricant type which stated on product label (see. **2.1 Gear Unit Label**, page 11). This situation means that just a product should be used convenient to the lubricant type that shown on the label. In particular situations, stated product's name is shown on gearbox product label.

Table 19: Lubrication Table

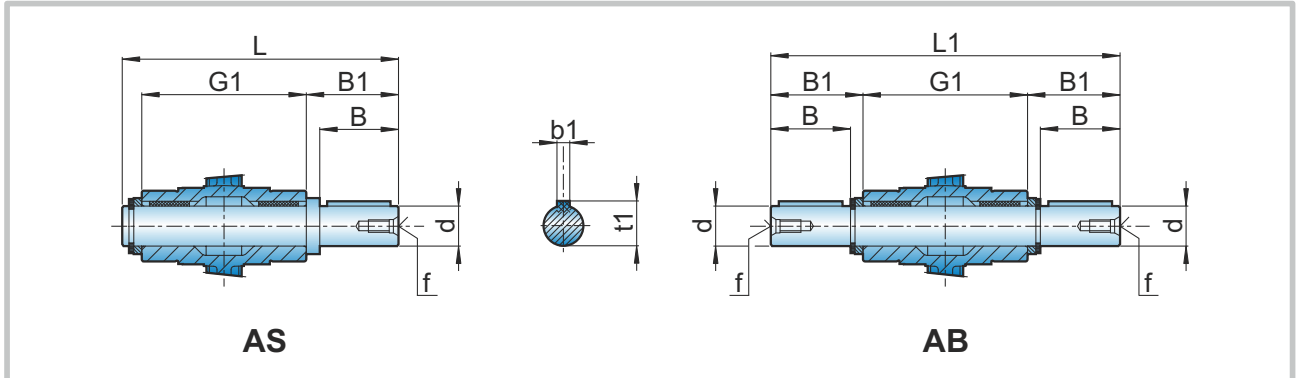
		T°C ISO SAE...	 Agip	 Shell	 Esso	 Mobil	 Castrol	 bp
 110 ... 150	Mineral oil	(-5) / (+40) ISO VG460	BLASIA 460	OMALA OIL460	SPARTAN EP460	MOBILGEAR 634	ALPHA MAX 460	ENERGOL GR-XP460
		(-15) / (+25) ISO VG220	BLASIA 220	OMALA OIL220	SPARTAN EP220	MOBILGEAR 630	ALPHA MAX 220	ENERGOL GR-XP220
 030 ... 105 PPC 063 ... 090	Synthetic oil	(-25) / (+50) ISO VG320	TELIUM VSF320	TIVELA OIL SC320	S220	GLYGOYLE 30	ALPHASYN PG320	ENERGOL SG-XP320

	<p>DANGER !</p> <p>The synthetic and mineral oils must not be mixed with eachother.</p>
	<p>NOTE !</p> <p>At ambient temperatures under -30° degree and above 60° degree for leakproofing element inside the shaft, special quality material must be used.</p>
	<p>NOTE !</p> <p>This table shows the oil types of different companies. Oils of different companies should not be mixed. Please contact NRW if you want to change the oil type and viscosity class. Otherwise we provide no guarantee for the function of the gearbox.</p>



7.1 Low Speed Shafts

Figure 8: Output Solid Shaft



	d	B	B1	G1	L	L1	f	b1	t1
030	14h6	30	32.5	63	102	128	M6	5	16
040	18h6	40	43	78	128	164	M6	6	20.5
050	25h6	50	53.5	92	153	199	M10	8	28
063	25h6	50	53.5	112	173	219	M10	8	28
075	28h6	60	63.5	120	192	247	M10	8	31
090	35h6	80	84.5	140	234	309	M12	10	38
105	42h6	80	84.5	155	249	324	M16	12	45
110	42h6	80	84.5	155	249	324	M16	12	45
130	45h6	80	85	170	265	340	M16	14	48.5
150	50h6	82	87	200	297	374	M16	14	53.5

Table 20: Output Solid Shaft

7.2 The Mounting of the Protection Caps

For preventing shrink disc and free rolling output shafts (the side which customer does not use) windings, a contact protection is required. A single protection cover (KK) could be placed as a contact protection.

- The protection cap must be attached with fixing bolts to the mounting place.
- Must be tightened with the proper torc.

Figure 9: Protection Cover



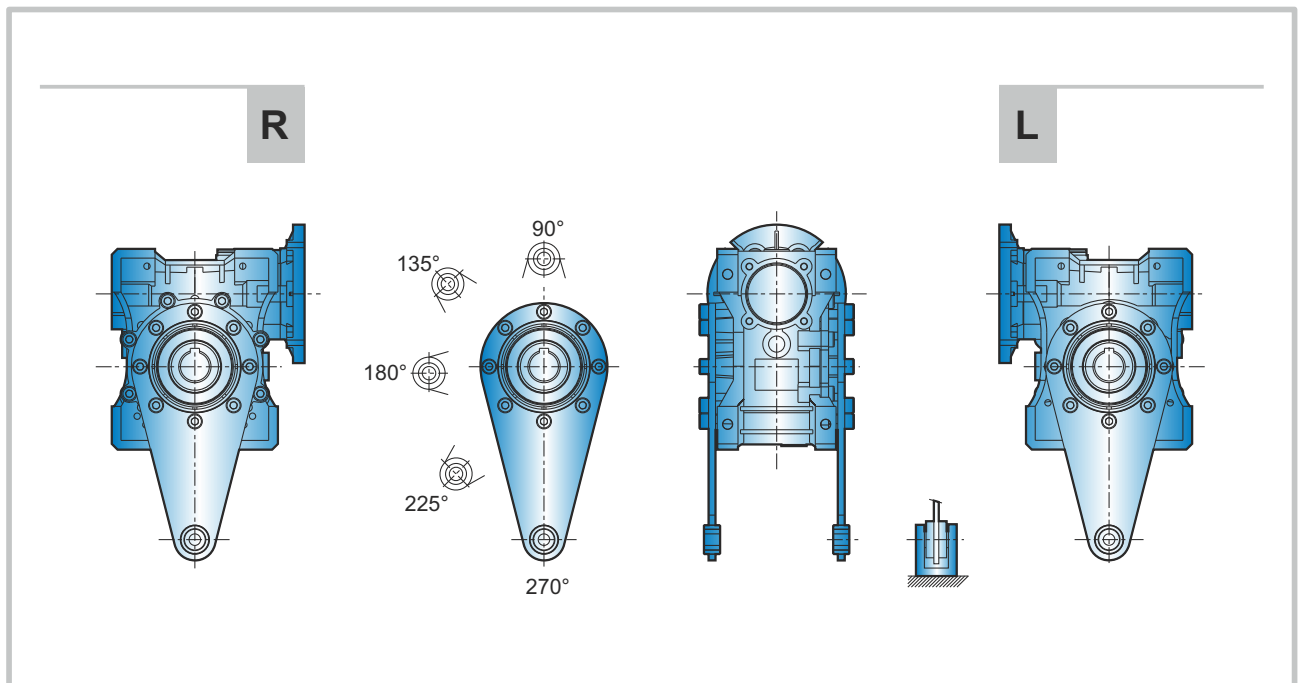


7.3 Torque Arm

- The rubber wedge part of the torque arm must be taken into the bearing from both sides.
- Torque arms must be mounted as a vibration-free.
- For the correct mounting, the sticky (LOCTITE 510 OR EQUIVALENT) which absorbs vibration must be used.
- The screw connection of the torque arm must be tightened with proper torque and must get into the safe against loosening (LOCTITE 510 or equivalent).

PMRV PLUS series gearboxes could be equipped with vibration isolator torque arm; after completing assembly, be sure that there is not axial preload of vibration isolator connection. (For PMRV PLUS series gearboxes to support both sides at connection). Please control that there would not any abnormal vibrations both at the product and backbone structure.

Figure 10: Torque Arm



Catalog : PMRV PLUS
Page : 97



7.4 Dimensions

PRV PLUS+

Figure 11: Input Shaft (PRV PLUS+)

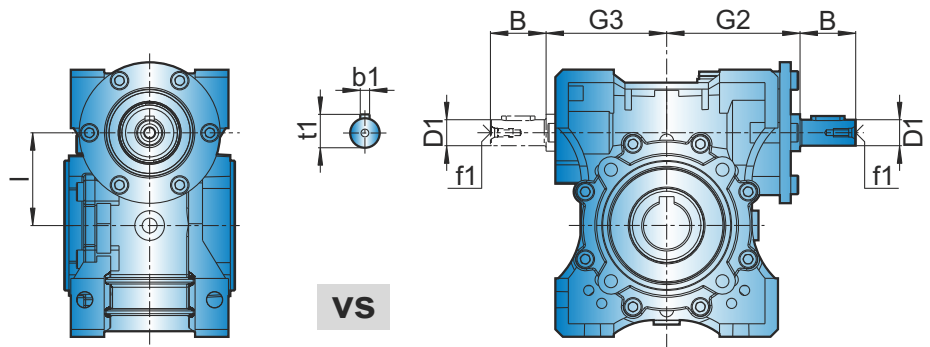


Table 21: Input Shaft (PRV PLUS+)

PRV PLUS+	030	040	050	063	075	090	105	110	130	150
B	20	23	30	40	50	50	60	60	80	80
D1	9 j6	11 j6	14 j6	19 j6	24 j6	24 j6	28 j6	28 j6	30 j6	35 j6
G2	51	60	74	90	105	125	142	142	162	195
G3	45	53	64	75	90	108	135	135	155	175
I	30	40	50	63	75	90	110	110	130	150
b1	3	4	5	6	8	8	8	8	8	10
f1	-	-	M6	M6	M8	M8	M10	M10	M10	M12
t1	10.2	12.5	16	21.5	27	27	31	31	33	38

PRV / PMRV PLUS+

Figure 12: Input Shaft (PRV / PMRV PLUS+)

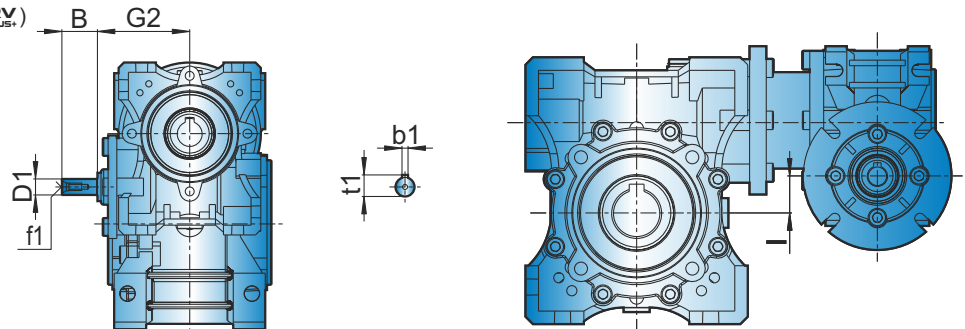


Table 22: Input Shaft (PRV / PMRV PLUS+)

PRV PLUS+ / PMRV PLUS+	030-040	030-050	030-063	040-075	040-090	050-105	050-110	063-130	063-150
B	20	20	20	23	23	30	30	40	40
D1	9 j6	9 j6	9 j6	11 j6	11 j6	14 j6	14 j6	19 j6	19 j6
G2	51	51	51	60	60	74	74	90	90
I	10	20	33	35	50	60	60	67	87
b1	3	3	3	4	4	5	5	6	6
f1	-	-	-	-	-	M6	M6	M6	M6
t1	10.2	10.2	10.2	12.5	12.5	16	16	21.5	21.5

For the missing dimensions, please consider the drawing of relevant **PMRV PLUS+** size.



7.4.1 PAM B5 Dimensions

Figure 13: PAM B5

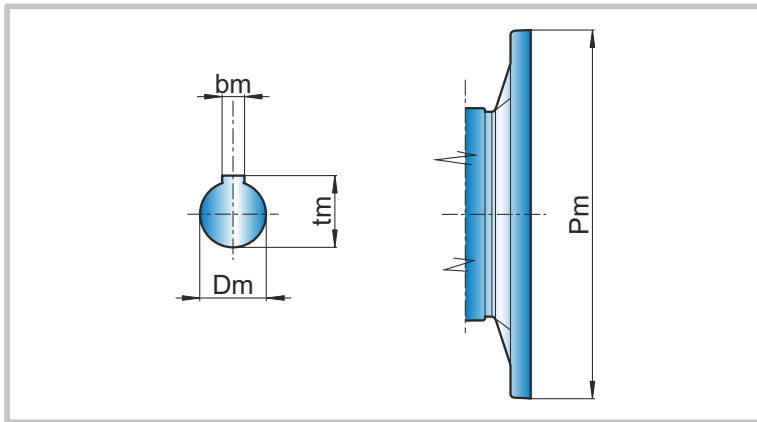


Table 23: PAM B5

B5	PAM										
	056	063	071	080	090	100	112	132	160	180	200
Pm	120	140	160	200	200	250	250	300	350	350	400
Dm	9	11	14	19	24	28	28	38	42	48	55
bm	3	4	5	6	8	8	8	10	12	14	16
tm	10.4	12.8	16.3	21.8	27.3	31.3	31.3	41.3	45.3	51.8	59.3

PMRV_{PLUS+} (110 - 130) tm= 40.3 (PAM 132)

7.4.2 PAM B14 Dimensions

Figure 14: PAM B14

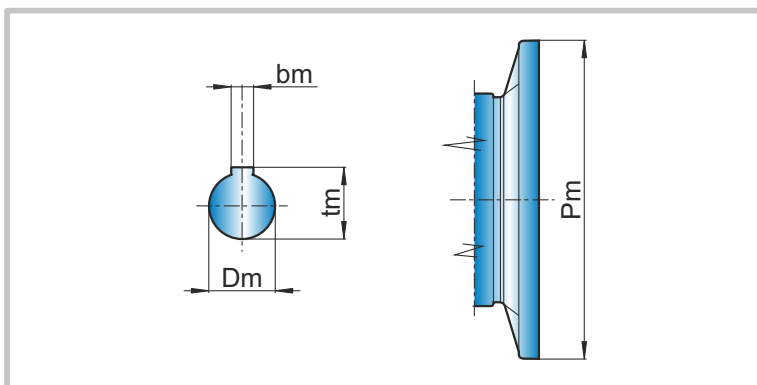


Table 24: PAM B14

B14	PAM							
	056	063	071	080	090	100	112	132
Pm	80	90	105	120	140	160	160	200
Dm	9	11	14	19	24	28	28	38
bm	3	4	5	6	8	8	8	10
tm	10.4	12.8	16.3	21.8	27.3	31.3	31.3	41.3

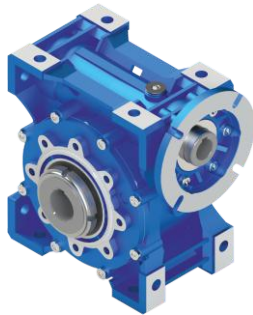
PMRV_{PLUS+} (110 - 130) tm= 40.3 (PAM 132)



7.5 Worm Gearmotors and Reducers with Torque Limiter

The torque limiter, in oil bath, is designed for sizes 050-063-075-090. The device assures the protection of the transmission from accidental high overloads which could damage the gearbox and the power transmission components. If necessary, it prevents reversing conditions of the worm gear unit by opportunely loosening the lock nut.

PMRL
PLUS+



Features:

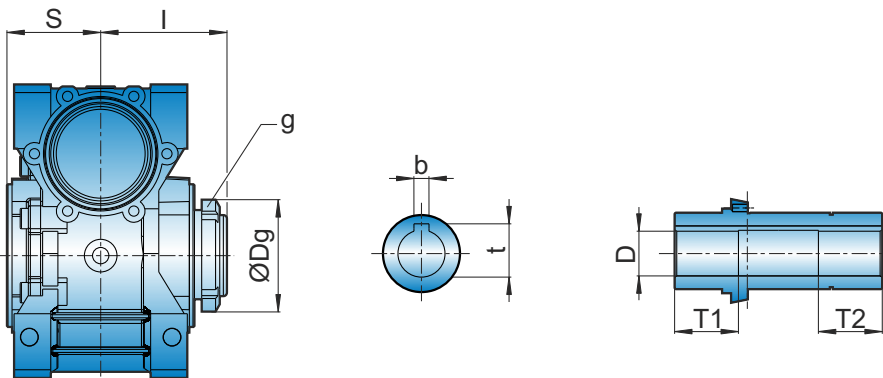
- External dimensions are almost the same as the version without torque limiter.
- No difference of the mountings.
- No difference of the hollow output shaft diameter with respect to the standard gearbox.
- The slipping torque can be easily adjusted by means of an external ring nut.
- No maintenance required on slipping components.
- Functional features are the same as standard version.

7.5.1 Torque Adjustment

The adjustment is carried out during assembly at about 80% of the nominal torque reported in the catalogue. This torque is transmitted by friction and so many factors could influence the adjustment value, like: temperature, running-in, vibrations, etc., therefore it is advised to adjust the torque limit by means of the lock nut when installing the gearbox on the machine, in accordance to application requirements.

7.6 PMRL Versions
PLUS+

Figure 15: Torque Limiter



D The torque limiter is supplied in D position.

Table 25: Torque Limiter

	I	S	Dg	g	b	t	D	T1	T2
050	63.5	46	56	M40x1.5	8	28.3	Ø25	33	33
063	74	56	62	M45x1.5	8	28.3	Ø25	37	37
075	78.5	60	68	M50x1.5	8	31.3	Ø28	40	40
090	89.5	70	80	M60x2	10	38.3	Ø35	45	45

For the missing dimensions, please consider the drawing of relevant **PMRV** size.
PLUS+



7.7 Backstop

Backstop prevents output shaft from rotation in the wrong direction. Depending on the type and size of the gearbox, the backstop can be installed to the case, input flange or motor. It is important to specify the required output rotation direction.



NOTE !

- The action of the motor in locking direction could cause fracturing of the lock.
- The motor absolutely must not rotated to the direction of locking. To provide specified direction of rotation, it must be careful that the motor is supplied by direct current.
- As a control, the output shaft/hollow shaft of the gearbox should be turned half a turn against the backstop direction.

The allowed direction of rotation is marked on the gear unit.
If the backstop direction is wrong, please contact NRW.



8.1 The Electrical Motor and Brake Connection

The connections must be made according to electric connection schema (If there is brake, it must be made according to brake connection schema).

- Must be sured that the supply voltage and frequency are the same as tag values.
- Both the protective tag values and connection must be controlled.
- If the motor is operated at the opposite direction, two stages must be changed.
- Unused cable entries should be closed.
- Not to have excessive load and stage failures, the protector must be used (stage protection or thermic etc.)
- The motor protection must be set to the nominal current.
- The gear unit and motor must be grounded against potential differences.
- The electrical motor and/or brake connections must be made by the experienced electric technicians.



DANGER !

Wrong voltage or connection would harm to electrical motor or environment.

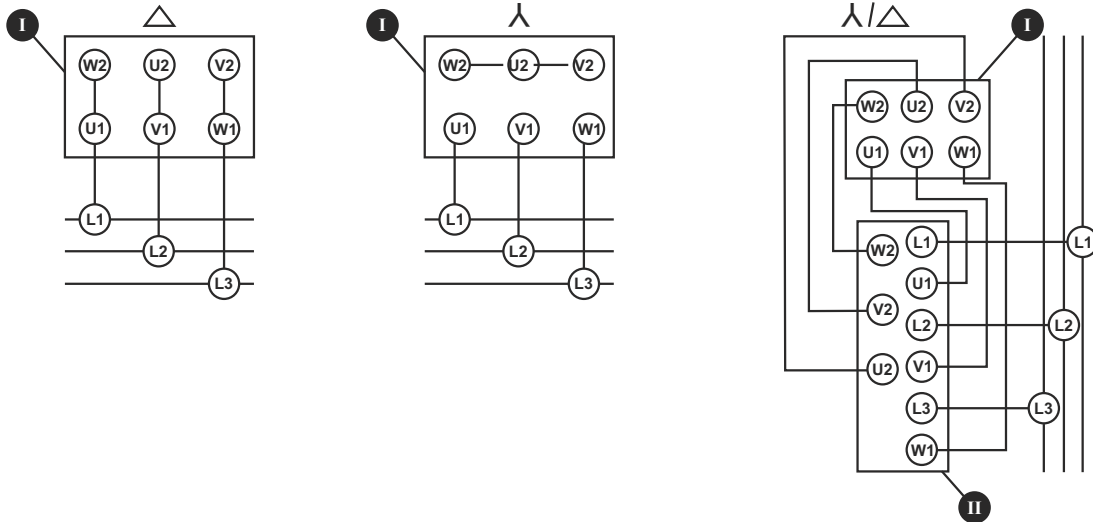


8.2 The Electrical Motor Connection Schema

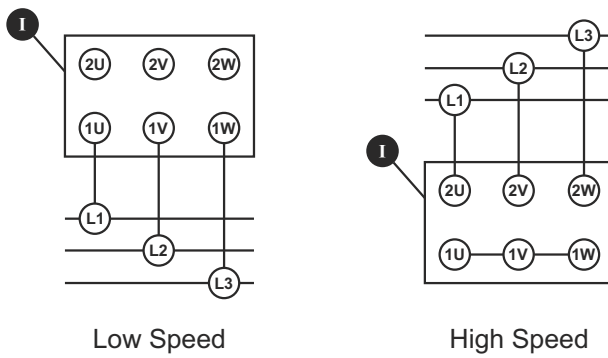
Three Phase Squirrel - Cage Motor

Figure 16: The Electrical Motor Connection Schema

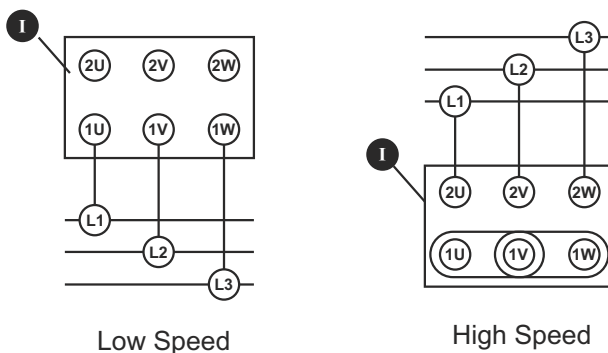
- I. Terminal Box
- II. Circuit Breaker



Wiring Diagram for Two - Separate - Winding Motor:



Dahlander Motor Connection Diagram:



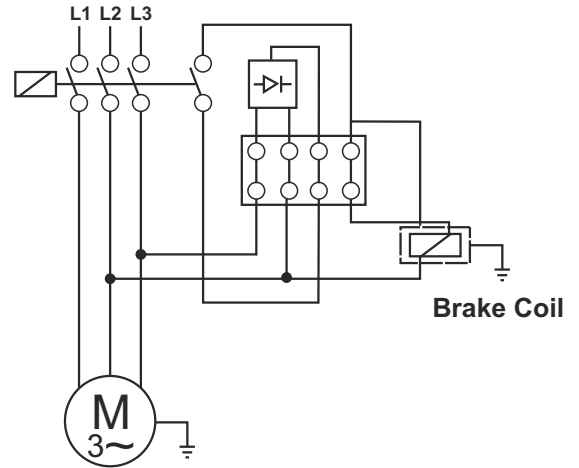
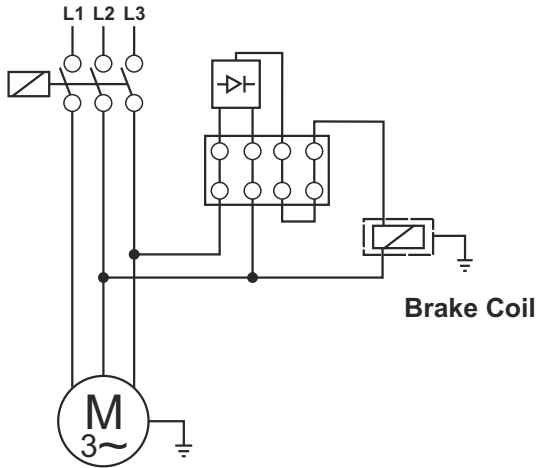


8.3 Standard Type Brake Anchorage Schema

Delayed Running Brake (400V)

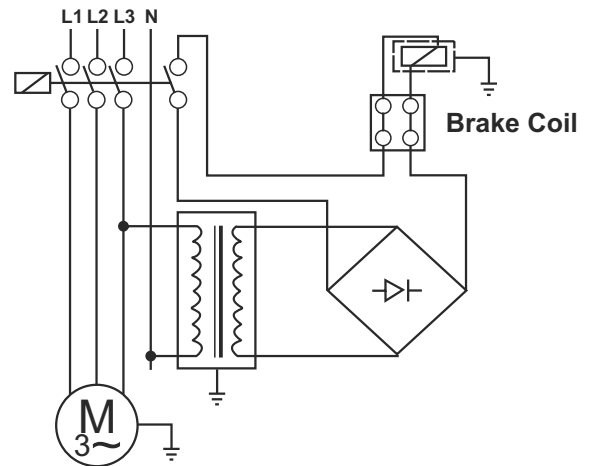
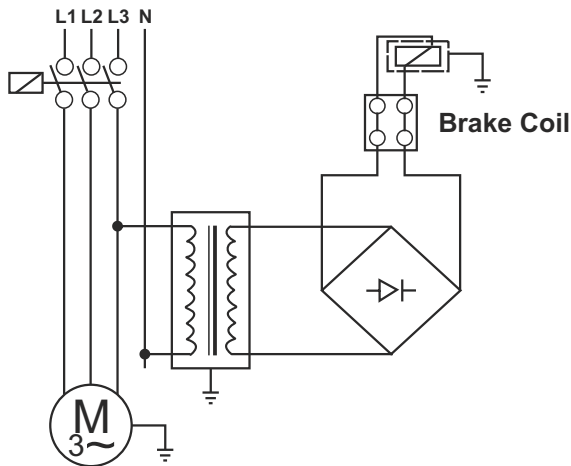
Sudden Brake (400V)

Figure 17: Standard Type Brake Anchorage Schema



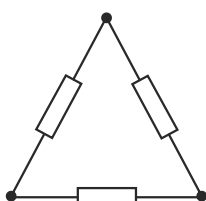
Delayed Running Brake (24V)

Sudden Brake (24V)

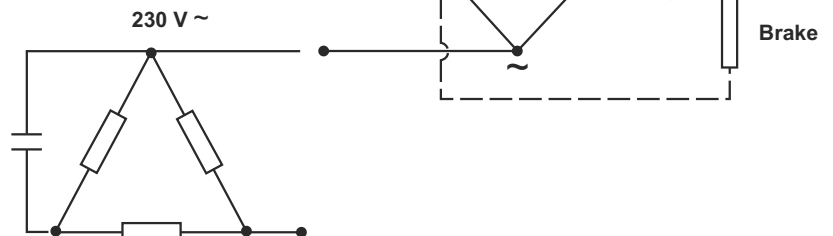
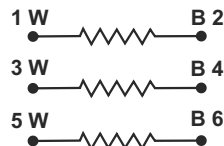
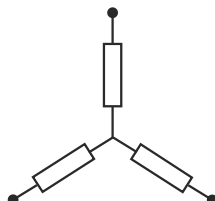


Please check brake coil by using a tester.

DELTA CONNECTION
Δ 230 V



STAR CONNECTION
Λ 400 V





9.1 Product Disposal

Dismantle the machine, separating the parts following the instructions given in this manual.

You must group the parts according to the materials they are made of: iron, aluminium, copper, plastic and rubber.

The parts must be disposed of by the relative centres in full compliance with the laws and force on the matter of dismantling and demolishing industrial waste.

Waste Oil: At the disposal of waste oil, please obey both to the environmental protection laws as well as rules and regulations those are in force into countries which the machine has been using of.

9.1.1 Disposal

The valid regulations must be taken into the consideration for the waste materials.

Table 26: Disposal Table

GEAR UNIT COMPONENTS	MATERIAL
Toothed wheels, shafts, rolling bearings, parallel keys, locking rings,...	Steel
Gear unit housing, housing components,...	Grey cast iron
Light alloy gear unit housing, light alloy gear unit housing components,...	Aluminium
Worm gears, bushes,...	Bronz
Radial seals, sealing caps, rubber components,...	Elastomers with steel
Coupling components	Plastic with steel
Flat seals	Asbestos - free sealing material
Gear oil	Additive mineral oil
Synthetic gear oil (rating plate code: CLP PG)	Polyglycol - based lubricants
Cooling spiral, embedding material of the cooling spiral, screw fittings	Copper, epoxy, yellow brass



NOTE !

Please do not diffuse any biologically indivisible materials, oil and noninclusive components (PVC,rubber,resins and etc.) to the environment.



ATTENTION !

Do not reuse damaged parts during inspection, only should be changed by expert personnels.



9.2 Troubleshooting

Table 27: Troubleshooting

NO	PROBLEM	OBSERVED	SOLUTION
①	Gearbox does not work.	The noise is not coming from gearbox. Output shaft of the gearbox is not rotating. Driver / frequency inverter is not be used.	Check the connection of electric motor, voltage and frequency. The values could be same with the values which are on the motor label. Look at to the motor usage guide. If the solution is not found look to the article 50.
②	Gearbox does not work.	The noise is not coming from gearbox. Output shaft of the gearbox is not rotating. Driver / frequency inverter is used.	Look to the guide of driver / frequency inverter or driver usage guide. Determine that error is not originated from driver / frequency inverter by seperating electric motor either from driver and frequency inverter and making direct connection to the motor.
③	Gearbox does not work.	A different noise is coming out of the gearbox. But gearbox and motor shaft are not rotating. Driver / frequency inverter or magnetic brake are not used.	The first thing that has to be made is to check whether motor connection, voltage and frequency are identical with motor label values. If there is not any problem, to pull out gearbox from the machine and try to operate in neutral. If gearbox works, the power of motor may not be enough to operate system. If the motor which connected to the gearbox is monophase, take off capacitors should be controlled. Even the motor does not work despite all tests and examinations, look at to the article 50.
④	Gearbox does not work.	A different noise is coming out of the gearbox. But gearbox and motor shaft are not rotating. Driver / frequency inverter or magnetic brake are used.	The frequency inverter or driver usage guide should be examined. Determine that error is originated whether from driver / frequency inverter by seperating electric motor either from driver and frequency inverter and making direct connection to the motor. If the gearbox does not work, look at to the article 50.
⑤	Gearbox does not work.	A different noise is coming out of the gearbox. But gearbox and motor shaft are not rotating. Magnetic brake is used.	It is necessary to check whether electric motor connection, voltage and frequency are identical with motor label values. Look at to the motor usage guide. Be sure that brake is working. If the brake is assembled by us to check whether it is made correctly according to the schema at the usage and maintenance instructions. If the error is not found to check whether the brake is operating by making direct connection to the brake appropriate to the brake voltage. When the electric is given, the noise of the opening of brake will come. If the brake is not working even by giving electric, the diode of brake could be in failure. To feed the motor directly according to the informations on the label when the brake is seperated from disc. If the problem is continuing, the power of the motor may not be enough. Look to the article 50.
⑥	Gearbox does not work at low speeds / frequencies.	Use driver / frequency inverter.	The motor feeding frequency is declining at low speeds. For the operating of motor at very low frequencies, it is essential to adjust motor parameters and frequency inverter parameters very well. Besides for the low speeds, there could be big changes even at the gearbox efficiency. To enlarge motor power and inverter or for to reach your requested cycle range, change the gearbox ratio.



NO	PROBLEM	OBSERVED	SOLUTION
7	Gearbox does not work after long awaitings or at mornings.	Environmental temperatures are dropping below -5°C.	The gearbox oil is not suitable to the environmental temperatures where it works. It is necessary to use low viscosity oils or to protect gearbox group from cold. To find proper oil look to usage guide or examine lubricating pages from the product catalogs. To work at higher environmental temperatures could be a solution. If the problem is continuing, the motor power should be increased.
8	Gearbox is very heating up.	You use worm screw type gearbox and environmental temperature is under +40°C.	When the gearbox is working under the full load, gauge gearbox surface temperature with heat meter. If it is under +90°C it is normal and no harm to gearbox. All worm screw and ATEX compatible helical gearboxes could be used up to the +120°C surface temperatures. If the temperature is above the +120°C and gearbox is ATEX compatible immediately stop gearbox and inform to NRW. Look to the article 50. If it is the product without ATEX, to check the oil amount according to the mountage position. Be sure that the mounting position written on the label and mounting position which gearbox is working should be identical. If not look to the article 50. To the gearboxes without worm screw types at heatings above +80°C, look to the articles 9 and 50.
9	Gearbox is very heating up.	You use helical gearboxes and environmental temperature is under +40°C.	When the gearbox is working under the full load, gauge gearbox surface temperature with heat meter. If it is under +90°C it is normal and no harm to the gearbox. All gearboxes with ATEX are designed to work at maximum +120°C. If the temperature is above +120°C and gearbox is ATEX compatible immediately stop gearbox and inform to NRW. The gearboxes without ATEX are designed to work at maximum +90°C temperature values. If the gearbox temperature is above the +90°C, control the oil amount according to mounting position. Be sure that the mounting position written on the label and mounting position which gearbox is working should be identical. If there is inconsistency look to the article 50.
10	Gearbox is very heating up.	Environmental temperature is above +40°C.	The standard gearboxes are designed to work at maximum +40°C. Temperatures above +40°C, special applications and additions should be done. In these situations please consult to NRW.
11	Gearbox is working noisy.	Noise is regular and perpetual.	Control the mobile machine elements. Operate gearbox without load by separating from the system. If you hear the same noise, bearings which belong to gearbox or motor could be in failure. Look to the article 50.
12	Gearbox is working noisy.	Noise is irregular.	Control the mobile machine elements. Operate gearbox without load by separating from the system. If the same noise is continuing, foreign objects could be in the oil. Change the oil and control the foreign objects in the oil. If the metal piece is found into the controlled oil, the gearbox could be damaged. Look to the article 50.



NO	PROBLEM	OBSERVED	SOLUTION
13	Gearbox is working noisy.	Noise is regular with clicking.	Control the mobile machine elements. Operate gearbox without load by separating from the system. If the same noise is continuing, gearbox parts could be damaged. Look to the article 50.
14	Gearbox is working noisy.	Noise is regular and fluctuating.	Control the flexure of connection elements which connect to output shaft. Separate element which is connected to output shaft and operate gearbox without load. If the same noise is continuing, look to the article 50.
15	Gearbox is working noisy.	Gearbox has motor with brake and noise is coming from the brake side.	The noises could be coming from the brake like in the shape of low level randomly tickings and it is normal. If the noise level is disturbing, brake could be damaged or there may be a problem at the gap adjustment between lining and disc. Look to the article 50.
16	Gearbox is working noisy.	You use frequency inverter and the noise is changing every time by the change of cycle.	Frequency inverter parameters may not be compatible with your used motor. Examine frequency inverter usage guide and if the same problem is continuing look to the article 50.
17	Oil leakage is existing.	Oil leakage from the seal.	If the environmental temperature is above +40°C and there is continuous working over 16 hours, according to the mounting position pull out a plug which is on the top and use ventilation plug instead of it. If your situation is not suited to this, seal could be damaged. Look to the article 50.
18	Oil leakage is existing.	Oil is leaking from the plug.	If you use the ventilation plug, be sure that the plug is at the right position. According to the mounting position of the gearbox, plug which is on the top could be ventilation plug. The plug may be loosened, clean the surface and plug itself and squeeze it again. If the same problem is continuing, look to the article 50.
19	Oil leakage is existing.	Oil is coming out of the housing.	To observe where the oil is exactly coming from. It is leaking from the oil plug, oil cover or seal and could flow onto the housing. If the situation is like this, look to the article 18 and 19. If you are sure that oil is coming out of the housing there could be cracks and fractures at the housing. Look to the article 50.
20	Oil leakage is existing.	Oil is coming out of the cover.	A gasket that is used between cover and housing is not performing its leak-tightness duty. Dismantle the cover, clean the bottom side and assemble cover to its place by smearing liquid gasket. If the problem continues, look to the article 50.
21	Gearbox is making regular vibrations when it is worked at the assemble point.	You use torque arm.	The reason for the vibration of gearbox is originated from the shaft flexure which gearbox is connected. When the torque arm is used, it has no harm to gearbox and it is usual situation.



NO	PROBLEM	OBSERVED	SOLUTION
22	Gearbox is making random vibrations when it is worked at the assemble point.	You use torc arm.	The reason of the vibration of gearbox is because of shaft flexure which the gearbox is connected and passing gap between shaft and bushing. Control your shaft hole passing tolerance. When the torc arm is used, it has no harm to gearbox and it is usual situation.
23	Motor is warming a lot.	Motor is working above its normal ampere. Environment is clear.	There could be overloading or motor power is insufficient. Motor could be in failure. Look to the article 50.
24	Motor is warming a lot.	Environment is dusty.	Be sure of whether motor fan bowl and motor cooler cores are clean for the air passing. If you use extra fan be sure that it is working. If there is invertor usage at the motor and works at low frequencies, the motor fan may not be sufficient. Use extra fan in these situations. If the problem continues look to the article 50.
25	Motor shaft is rotating but gearbox shaft is not.	Friction noise is coming from inside of gearbox or only there is motor noise.	There could be a damage at the gearbox parts. Look to the article 50.
26	Motor shaft is rotating but gearbox shaft is not.	You use chain geared or pinion geared at the output shaft of gearbox.	The damage could be originated of poligon impact formed by chain geared or from the radial load. Gearbox connection points may not be rigid enough. Be sure that you are able to use proper chain geared and pinion geared for used gearbox. Recalculate maximum allowable radial load according to this position. Look to the article 50.
27	Output shaft is cut.	You use either chain geared or pinion geared.	The damage could be originated of poligon impact formed by chain geared or from the radial load. Gearbox connection points may not be rigid enough. Be sure that you are able to use proper chain geared and pinion geared for used gearbox. Recalculate maximum allowable radial load according to this position. Look to the article 50.
28	Gearbox is stopping too late.	You use motor with brake	Control the electric connection schema of brake. Be sure that there is not assembled delayed diode onto the brake. If there is delayed diode, it could be changed. (Hoisting gearboxes are excluded PCS)
50	Service is required.	Informing of NRW Company.	Please contact with NRW company. Communication informations are given at the usage guides,catalogs. Mechanical parts can only be changed either by NRW or within the knowledge. Any change that is to be made without the knowledge of NRW would cancel both guarantee of product and all certificate declerations and remove the responsibilities of NRW over the product.

If there are problems or malfunctions different to the onesdescribed here contact a NRW Industries Assistance Centre.



10.1 Authorized Service

They are skill and qualified people, which are determined by company. They have education about electrical and mechanical subject.

	NOTE !
<p>At below; the list took in place decided by our firm, authorized service and customer (user) which is about control and maintenance criterias/applications. Must be obliged to the informations which were given in the list. To the contrary that Usage and Maintenance directions become invalid.</p>	

Table 28: Authorized Service

No	CRITERIA	MANUFACTURER (NRW)	AUTHORIZED SERVICE	CUSTOMER (USER)
1	Disassembly of geared unit	✓	✓	X
1.1	Case changing	✓	✓	X
1.2	Gear changing	✓	✓	X
1.3	Solid / shaft changing	✓	✓	X
1.4	Changing of all consumable material except sealing materials	✓	✓	X
2	Oil cup changing	✓	✓	✓
3	Seal changing	✓	✓	✓
4	Oil changing	✓	✓	✓
5	Motor montage to IEC adapter type	✓	✓	✓
6	Motor montage to PAM type	✓	✓	✓
7	Assembly of geared unit with W cylinder type	✓	✓	✓
8	Disassembly of motor from IEC / PAM type	✓	✓	✓

✓ : SUITABLE

X : NOT SUITABLE

2-3 : Send to the contaminated waste disposal (licensed firm).

4 : Send to the licensed firm for the purpose of disposal.



11.1 Contact Information

FACTORY

IN DER SCHLINGE 6, D-59227 Ahlen / **GERMANY**

Tel : +49 (0) 238 2855 7010
: +49 (0) 238 2855 7011
: +49 (0) 238 2855 7012
: +49 (0) 238 2855 7016
Fax : +49 (0) 238 2855 7015
Web : www.nrwdrivetechnologies.com
e-mail : info@nrwdrivetechnologies.com

ATA OSB MAH. ASTİM 1. CAD. NO: 4, PK 105 Efeler / Aydın / **TURKEY**

Tel : +90 256 231 19 12 - 16 (pbx)
Fax : +90 256 231 19 17
Web : www.pgr.com.tr
e-mail : info@pgr.com.tr - satissonrasi@pgr.com.tr

NRW[®]
DRIVE TECHNOLOGIES

EN

NRW[®]

EN



- In der Schlinge 6, D-59227 Ahlen / GERMANY
- T: +49 (0) 238 2855 7010
- F: +49 (0) 238 2855 7015
- info@nrwdrivetechnologies.com
- www.nrwdrivetechnologies.com